

KUBE

KUBE
collection

VICTORIA

VICTORIA



VICTORIA

KUBE COLLECTION

.....

ITA È un inno alle forme squadrate e pulite, ora esasperate, ora ingentilite, ora accese, ora smussate da lavabi, finiture e accessori.

ENG An ode to square uncluttered lines, at times exaggerated, at times softened, sometimes bold, sometimes subdued by washbasins, finishes and accessories.

DEU Eine Hymne an kantige und klare Formen, die von Waschbecken, Ausführungen und Zubehör teils betont, teils veredelt, teils akzentuiert, teils abgerundet werden.

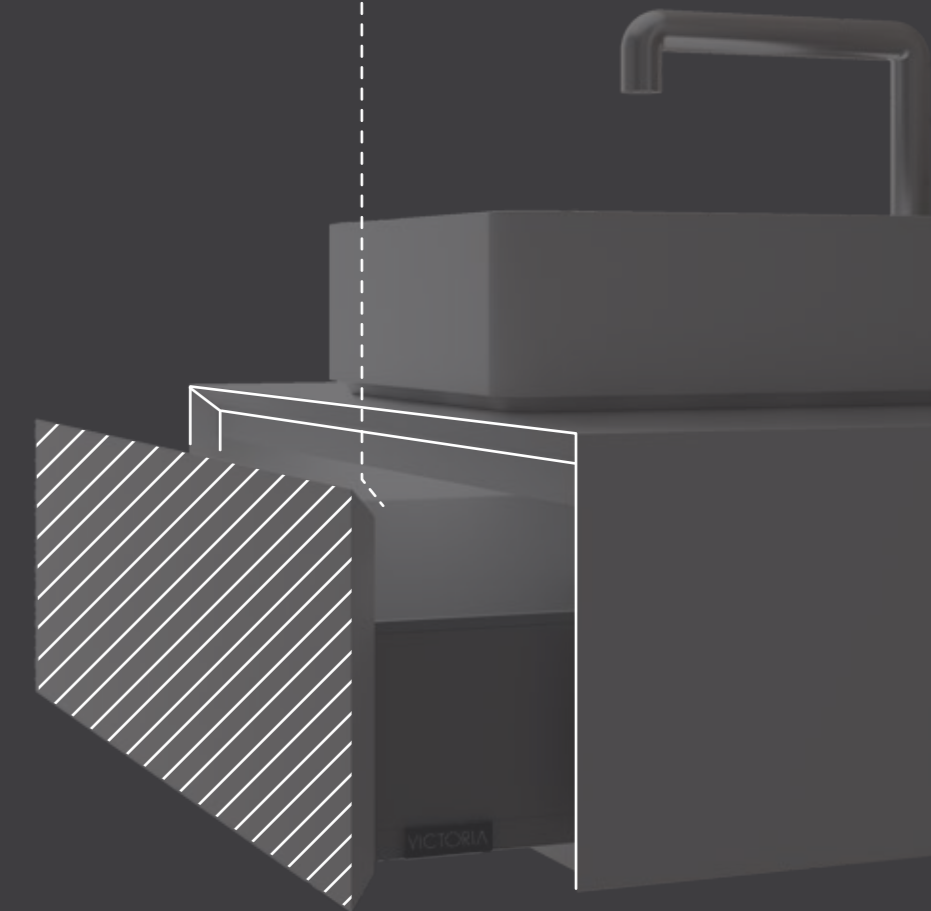
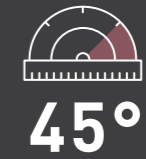

ITA

Anta e scocca sono tagliate a 45° per consentire una chiusura perfetta e creare un effetto monoblocco con l'apertura a gola. In alternativa c'è l'apertura dal basso, capace di esasperare ancora di più la forma semplice, lineare, in un unico pezzo. Il risultato è di assoluto rigore.

ENG

Door and carcass are cut at 45° to allow perfect closing and create the effect of a single unit with the grip profile. As an alternative the door can be opened from the bottom, making even more evident the simple linear shape of a single unit. The result is absolute rigour.

DEU

Tür und Korpus haben eine 45°-Schräge, damit die Tür perfekt schließt, wobei durch die als Griff dienende Hohlkehle eine Monoblockoptik entsteht. Als Alternative steht die Öffnung von unten zur Verfügung, mit der die schlichte, lineare Form aus einem Stück noch mehr betont wird. Das Resultat lässt absolute Strenge erkennen.



KUBE

Composizioni
Compositions / Anbaulösungen

[PP. 06-69](#)

Finiture
Finishes / Ausführungen

[PP. 71-74](#)

Abbinamenti
Coordinates / Zusammenstellungen

[PP. 75-77](#)



COMP 130

composition 130
anbaulösung 130

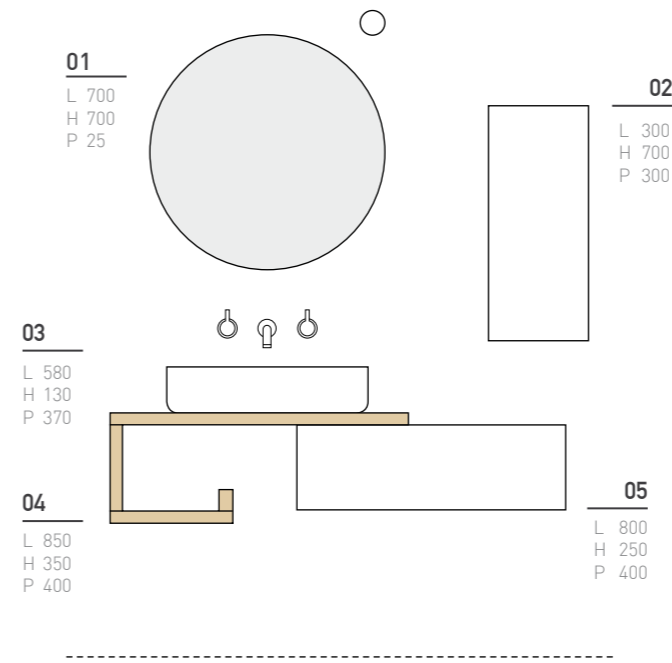

Composizione 130

Composition 130 / Anbaulösung 130

Il piano in rovere è personalizzabile:
con due pannelli in più crea un
pratico vano a giorno. I

The oak top can be customized:
two extra panels create a practical
open unit. E

Die Waschtischplatte aus Eiche
kann individuell gestaltet werden:
mit zwei zusätzlichen Platten
entsteht ein praktisches offenes
Fach. D

Finiture o

Finishes / Oberflächen

Specchio circolare Ø70 01
Ø70 circular mirror
Runder Spiegel Ø70

Pensile in laccato opaco bianco 9003 02
9003 white matt lacquered wall unit
Hängeschrank in Lack Matt Weiß 9003

Lavabo in mineralmarmo 03
Mineralmarble washbasin
Waschbecken aus Mineralguss

Mensolone in Matrix rovere sbiancato 01 04
Large shelf in 01 Matrix oak "sbiancato"
Ablagebord aus Matrix Eiche "sbiancato" 01

Base in laccato opaco bianco 9003 05
9003 white matt lacquered base unit
Unterschrank in Lack Matt Weiß 9003

Accessori ←

Accessories / Zubehör

Lampada con fissaggio a parete
Wall fitted lamp
Lampe mit Wandbefestigung

ART. 4514



Superfici a confronto: metallo
freddo e severo, rovere materico,
mineralmarmo elegante al tatto.

—

Surface face-off: cold severe
metal, textured oak, elegant to
the touch mineralmarble.

—

Oberflächen im Vergleich:
kaltes und strenges Metall,
Eiche mit Materialoptik,
berührungsfreundlicher,
eleganter Mineralguss.



COMP 131

composition 131
Anbaulösung 131



Composizione 131

Composition 131 / Anbaulösung 131

I **Composizione compatta ma capiente, dotata anche di un considerevole spazio d'appoggio.**

E **A compact but capacious composition that also boasts plenty of useful tops.**

D **Kompakte, doch geräumige Anbaulösung, die auch über eine große Abstellfläche verfügt.**

o Finiture

Finishes / Oberflächen

01 **Specchio retroilluminato**
Backlit mirror
Hinterleuchteter Spiegel

02 **Pensile in laccato opaco bianco 9003**
9003 white matt lacquered wall unit
Hängeschrank in Lack Matt Weiß 9003

03 **Lavabo in Corian®**
Corian® washbasin
Waschbecken aus Corian®

04 **Basi in laccato opaco bianco 9003**
9003 white matt lacquered base units
Unterschränke in Lack Matt Weiß 9003

→ Accessori

Accessories / Zubehör

Lampada con fissaggio a parete
Wall fitted lamp
Lampe mit Wandbefestigung

ART. 4514

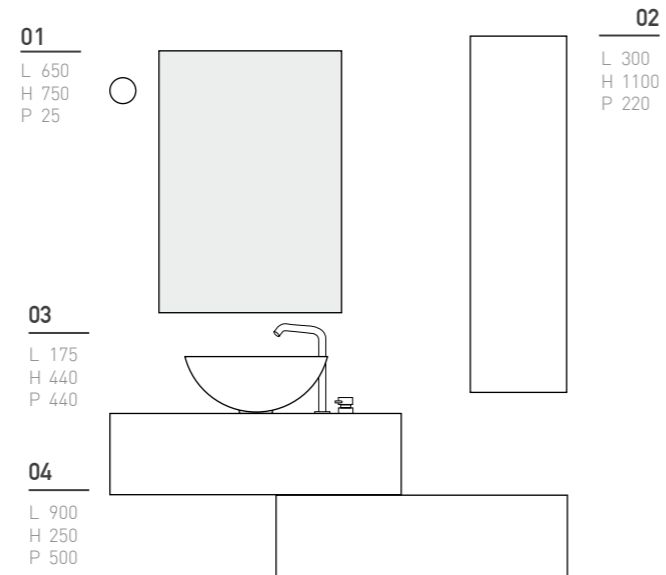

Il lavabo in appoggio sul piano
è in Corian®, materiale igienico,
resistente ed elegante.

—

The washbasin sits on a top in
Corian®, an elegant but robust
hygienic material.

—

Das auf die Waschtischplatte
aufgesetzte Waschbecken ist aus
Corian®, einem hygienischen,
widerstandsfähigen und
eleganten Material.





COMP 132

composition 132
anbaulösung 132



Composizione 132

Composition 132 / Anbaulösung 132

01

L 700
H 700
P 25

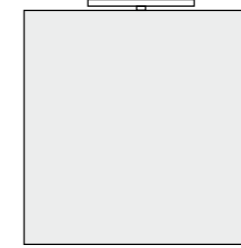

03

L 370
H 130
P 370

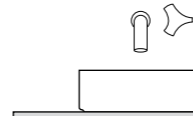

02

L 900
H 250
P 350

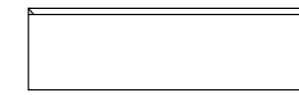

04

L 1100
H 120
P 500



Una soluzione semplice con
lavabo in ceramica, arricchita
dal piano in marmo bianco di
Carrara. I

A simple solution with a ceramic
washbasin enhanced by a white
Carrara marble top. E

Eine schlichte Lösung mit
Waschbecken aus Keramik, die
durch eine Waschtischplatte
aus weißem Carrara-Marmor
aufgewertet wird. D

Finiture

Finishes / Oberflächen

Specchio retroilluminato 01
Backlit mirror
Hinterleuchteter Spiegel

Base in laccato opaco bianco 9003 02
9003 white matt lacquered base unit
Unterschrank in Lack Matt Weiß 9003

Lavabo in ceramica 03
Ceramic washbasin
Waschbecken aus Keramik

Top in marmo bianco di Carrara 04
White Carrara marble top
Waschtischplatte aus weißem Carrara-Marmor

Accessori

Accessories / Zubehör

Lampada a LED
LED lamp
LED-Lampe

ART. 4517





I tagli a 45° della scocca e dell'anta sono utilizzati per creare la pratica apertura a gola.

—

45° cuts on the carcase and door are used to create a practical grip profile.

—

Die 45°-Schrägen an Korpus und Tür werden verwendet, um die praktische Öffnung mit Hohlkehle zu erzielen.



COMP 133

composition 133
anbaulösung 133



Composizione 133

Composition 133 / Anbaulösung 133

I Le composizioni a doppio lavabo sono soluzioni di estrema comodità per i bagni padronali.

E Compositions with two washbasins are extremely practical in master bathrooms.

D Die Anbaulösungen mit zwei Waschbecken sind besonders praktisch für Familienbäder.

○ Finiture

Finishes / Oberflächen

- 01 Specchi retroilluminati
Backlit mirrors
Hinterleuchteter Spiegel
- 02 Lavabi in mineralmarmo
Mineralmarble washbasins
Waschbecken aus Mineralguss
- 03 Basi in laccato opaco bianco 9003
9003 white matt lacquered base unit
Unterschränke in Lack Matt Weiß 9003
- 04 Base in rovere grigio tranché
"Grigio tranché" oak base unit
Unterschrank aus Eiche "grigio tranché"

→ Accessori

Accessories / Zubehör

Lampada a LED cromata
Chrome plated LED lamp
Verchromte LED-Lampe

ART. 4517

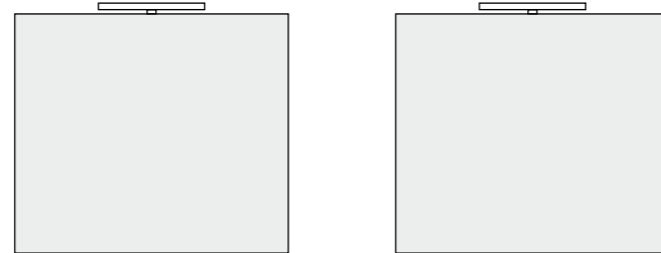
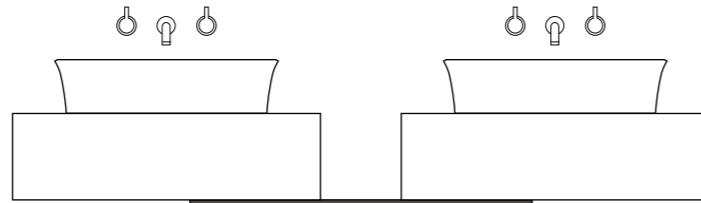
**01**L 800
H 700
P 25**02**L 580
H 140
P 380**03**L 900
H 250
P 400**04**L 1000
H 250
P 400



Semplice ingentilire forme squadrate con un lavabo da appoggio e rubinetteria dalle linee dolci.

—

It's easy to soften squared shapes with the gentle lines of a sit-on washbasin and taps.

—

Kantige Formen lassen sich mit aufgesetztem Waschbecken und schön geformten Armaturen leicht anmutiger gestalten.

COMP 134
.....

composition 134
anbaulösung 134





Un tocco di colore dà carattere.
La collezione Kube permette la
scelta a piacere dalla scala RAL.

—

A touch of colour provides
character. With the Kube
collection you can choose your
preference from the RAL scale.

—

Ein Farbakzent verleiht Charakter.
Die Kollektion Kube bietet freie
Wahl aus den RAL-Farben.





Composizione 134

Composition 134 / Anbaulösung 134

01

L 900
H 700
P 25

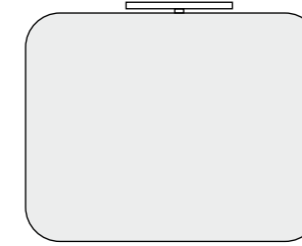

03

L 700
H 15
P 400

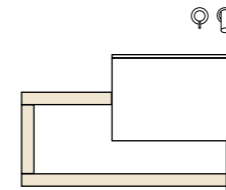

04

L 620
H 290
P 400



02

L 700
H 250
P 400



05

L 800
H 250
P 500



Composizione compatta, perfetta anche per i bagni di servizio, alleggerita dal vano a giorno.

A compact composition comprising an open unit that gives a spacious air to small rooms such as separate toilets.

Eine kompakte Anbaulösung, perfekt auch für Gästebäder, die durch das offene Fach leichter wirkt.

Finiture

Finishes / Oberflächen

Specchio con angoli stondati 01
Mirror with rounded corners
Spiegel mit abgerundeten Ecken

Base in laccato opaco bianco 9003 02
9003 white matt lacquered base unit
Unterschrank in Lack Matt Weiß 9003

Lavabo rettangolare a incasso in mineralmarmo 03
Inset rectangular washbasin in mineralmarble
Rechteckiges Einbauwaschbecken aus Mineralguss

Mensolone in laminato Sherwood 70 04
Large shelf in Sherwood 70 laminate
Ablagebord aus Laminat Sherwood 70

Base in laccato opaco 6033 05
6033 matt lacquered base unit
Unterschrank in Lack Matt 6033

Accessori

Accessories / Zubehör

Lampada a LED cromata
Chrome plated LED lamp
Verchromte LED-Lampe

ART. 4517





COMP 135

composition 135
anbaulösung 135

Composizione 135

Composition 135 / Anbaulösung 135

I Con Kube i vani a giorno in legno sono sempre personalizzabili nelle forme e nelle misure.

E The shape and sizes of wooden open units in the Kube collection can always be customized.

D Mit Kube können die Formen und Maße der offenen Fächer aus Holz immer individuell gestaltet werden.

o Finiture

Finishes / Oberflächen

01 Vano a giorno in rovere miele tranché
Open unit in "miele tranché" oak
Offenes Fach aus Eiche "miele tranché"

02 Specchio con ingrandimento
Magnifying mirror
Spiegel mit Vergrößerung

03 Lavabo in mineralmarmo
Mineralmarble washbasin
Waschbecken aus Mineralguss

04 Base in laccato opaco bianco 9003
9003 white matt lacquered base unit
Unterschrank in Lack Matt Weiß 9003

→ Accessori

Accessories / Zubehör

LED integrati nel vano a giorno
LED integrated into the open unit
Offenes Fach mit LED-Einbaustrahlern

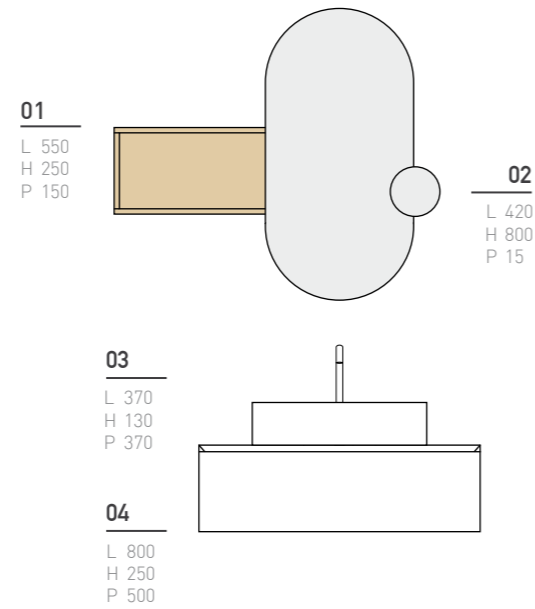



Il particolare fa apprezzare come l'apertura a gola rispetti la linearità e la pulizia del mobile.

—

The detail highlights the fact that the grip profile contributes to the uncluttered linear design of the fitting.

—

Das Detail lässt erkennen, wie die Tür mit Hohlkehle die Linearität und Reinheit des Schrankes betont.



COMP 136

composition 136
anbaulösung 136





Composizione 136

Composition 136 / Anbaulösung 136

01

L 900
H 700
P 150

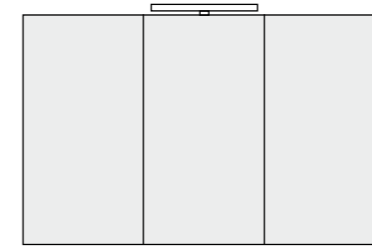

02

L 800
H 250
P 200



03

L 1200
H 15
P 500

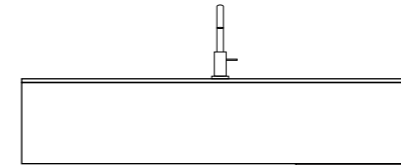

04

L 1200
H 250
P 500



05

L 700
H 250
P 500



Una proposta per un bagno principale, sviluppata in orizzontale, con ampia superficie a specchio.

An idea for a master bathroom, developed horizontally, with a large mirror surface.

Eine horizontal verlaufende Einrichtungsidee für ein Familienbad mit großer Spiegelfläche.

Finiture

Finishes / Oberflächen

Specchio contenitore 01
Storage mirror
Spiegelschrank

Vano a giorno in laminato Beverin 02
Beverin laminate open unit
Offenes Fach aus Laminat Beverin

Lavabo rettangolare in mineralmarmo 03
Rectangular washbasin in mineralmarble
Rechteckiges Waschbecken aus Mineralguss

Base in laccato opaco bianco 9003 04
9003 white matt lacquered base unit
Unterschrank in Lack Matt Weiß 9003

Basi in laminato Beverin 05
Beverin laminate base units
Unterschranke aus Laminat Beverin

Accessori

Accessories / Zubehör

Lampada a LED
LED lamp
LED-Lampe

ART. 4517





La parte inferiore delle ante a specchio è più lunga del pensile e ne permette l'apertura.

—

The bottom part of the mirror door is longer than the wall unit to provide an opening grip.

—

Der untere Teil der Spiegeltüren ist länger als der Hängeschrank und dient zum Öffnen.



COMP 137 A

composition 137 A
anbaulösung 137 A



Composizione 137 A

Composition 137 A / Anbaulösung 137 A

I Sopra il mobile con doppio cassetto, uno specchio con cornice della stessa finitura, personalizzabile nelle misure.

E Above the fitting with double drawer there is a mirror with a frame in the same finish. The size of the mirror can be customized.

D Über dem Schrank mit zwei Schubkästen hängt ein gerahmter Spiegel in der gleichen Ausführung, dessen Maße individuell gestaltet werden können.

o Finiture

Finishes / Oberflächen

01 Specchio con cornice in laminato Sherwood LN66
Mirror with frame in Sherwood LN66 laminate
Gerahmter Spiegel aus Laminat Sherwood LN66

02 Lavabo rettangolare in mineralmarmo
Rectangular washbasin in mineralmarble
Rechteckiges Waschbecken aus Mineralguss

03 Base con gola in laminato Sherwood LN66
Base unit with grip profile in Sherwood LN66 laminate
Unterschrank mit Hohlkehle aus Laminat Sherwood LN66

→ Accessori

Accessories / Zubehör

LED integrati nello specchio
LED integrated into the mirror
Spiegel mit LED-Einbaustrahlern

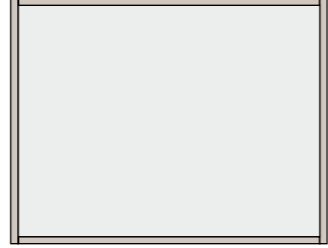
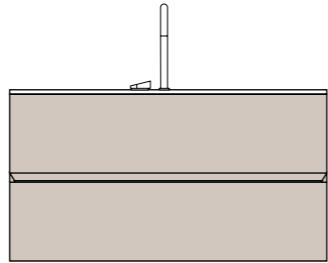
01L 900
H 700
P 80**03**L 900
H 500
P 500**02**L 900
H 15
P 500



Con il doppio cassetto la gola è unica: serve per aprire sia il cassetto superiore sia l'inferiore.

—
There is a single grip profile for the double drawer: it is used to open both the top and bottom drawer.

—
Zwei Schubkästen mit nur einer Hohlkehle: sie dient zum Öffnen des oberen und unteren Schubkastens.





COMP 137 B

composition 137 B
anbaulösung 137 B



Composizione 137 B

Composition 137 B / Anbaulösung 137 B

01

L 1200
H 650
P 50

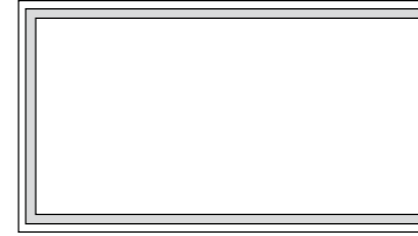

03

L 1200
H 500
P 500

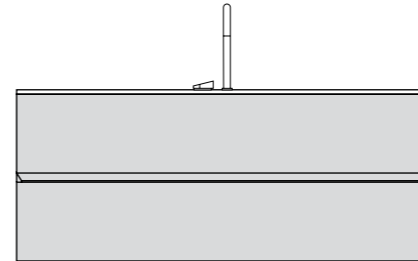

02

L 1200
H 12
P 500



I
Stesso mobile della composizione precedente, atmosfera tutta diversa grazie a finiture e dettagli.

E
The same fitting as the one in the previous composition; finishes and details provide a completely different atmosphere.

D
Der gleiche Schrank wie bei der vorherigen Anbaulösung, wobei Ausführungen und Details eine ganz andere Atmosphäre schaffen.

Finiture **O**

Finishes / Oberflächen

01
Specchio con LED integrati
Mirror with integrated LEDs
Spiegel mit LED-Einbaustrahlern

02
Lavabo rettangolare in mineralmarmo
Rectangular washbasin in mineralmarble
Rechteckiges Waschbecken aus Mineralguss

03
Base con gola in laminato Beton
Base unit with grip profile in Beton laminate
Unterschrank mit Hohlkehle aus Laminat Beton

COMP 138

composition 138
anbaulösung 138



Composizione 138

Composition 138 / Anbaulösung 138

- I Per dare un tono inconsueto a un ambiente bastano un colore frizzante e un'illuminazione originale.
- E To give a room an unusual air just add a sparkling colour and original illumination.
- D Um dem Raum eine außergewöhnliche Note zu verleihen, reichen eine spritzige Farbe und eine originelle Beleuchtung.

○ Finiture

Finishes / Oberflächen

- 01 Specchio retroilluminato
Backlit mirror
Hinterleuchteter Spiegel
- 02 Pensili in laccato opaco 7011
Wall units in 7011 matt lacquered
Hängeschränke in Lack Matt 7011
- 03 Vano a giorno in laccato opaco 1018
Open unit in 1018 matt lacquered
Offenes Fach in Lack Matt 1018
- 04 Vano a giorno in laccato opaco 7047
Wall unit in 7047 matt lacquered
Offenes Fach in Lack Matt 7047
- 05 Lavabo in ceramica
Ceramic washbasin
Waschbecken aus Keramik
- 06 Basi in laminato Beton
Base units in Beton laminate
Unterschränke aus Laminat Beton

→ Accessori

Accessories / Zubehör

Lampada a LED
LED lamp
LED-Lampe

ART. 4522

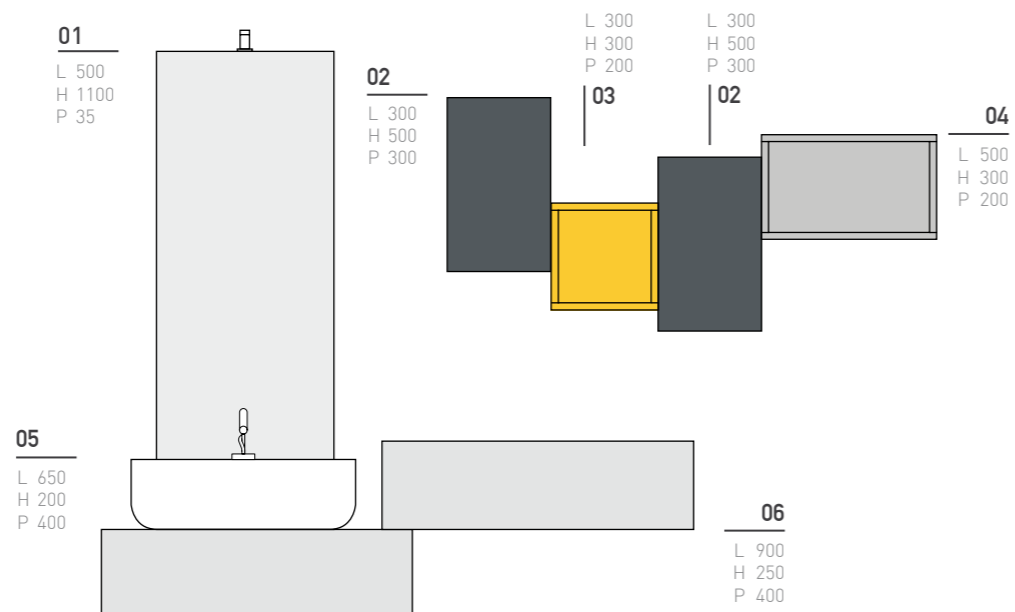



Soluzione particolarmente articolata, privilegia lo spazio per contenere e riporre, anche a vista.

—

A particularly articulated solution privileges storage space, also visible.

—

Stark gegliederte Anbaulösung, die viel Stauraum und Abstellmöglichkeiten bietet, auch auf offenen Regalen.





COMP 139

composition 139
anbaulösung 139



Composizione 139

Composition 139 / Anbaulösung 139

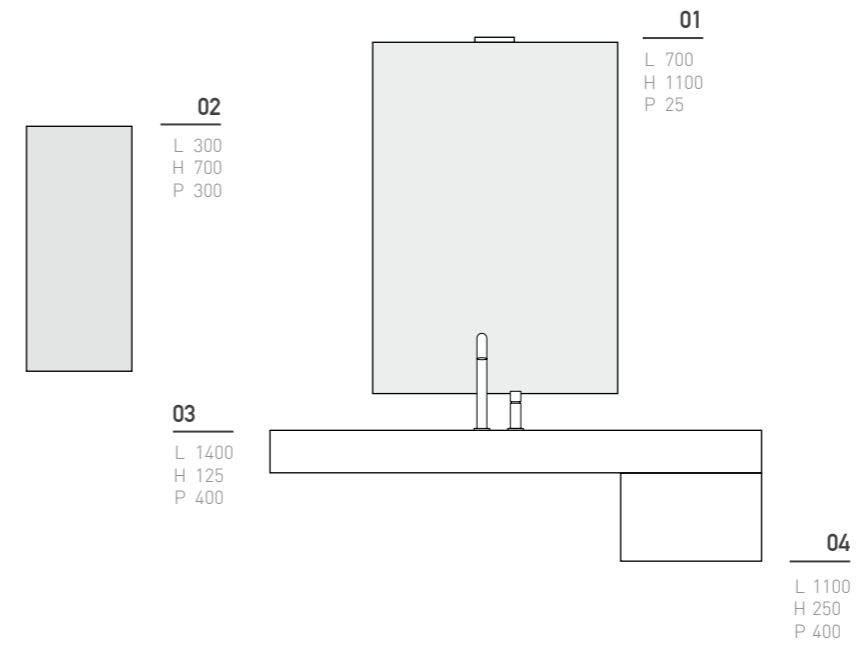

Ampia composizione ad angolo, I
realizzabile anche in dimensioni
più contenute per i bagni di
servizio.

A large corner composition, also E
available in a smaller version for
a separate toilet.

Große Eckenbaulösung, die auch D
mit kleineren Abmessungen für
Gästebäder erhältlich ist.

Finiture o

Finishes / Oberflächen

Specchio rettangolare 01
Rectangular mirror
Rechteckiger Spiegel

Pensile in laccato opaco bianco 9003 02
9003 white matt lacquered wall unit
Hängeschrank in Lack Matt Weiß 9003

Mensolone con lavabo integrato in Corian® 03
Large shelf with integrated washbasin in Corian®
Bord mit integriertem Waschbecken aus Corian®

Basi in laccato opaco bianco 9003 04
9003 white matt lacquered base units
Unterschranke in Lack Matt Weiß 9003

Accessori ←

Accessories / Zubehör

Lampada a LED cromata
Chrome plated LED lamp
Verchromte LED-Lampe

ART. 4521





La base in laminato bianco è attrezzata con cestoni capaci per disporre di un ampio spazio contenitivo.

—

A base unit in white laminate comes with capacious baskets to provide plenty of storage space.

—

Der Unterschrank aus weißem Laminat ist mit geräumigen Körben eingerichtet, um viel Stauraum zu bieten.



FINITURE



Finishes / Ausführungen

LAMINATI

Laminates / Laminate



laminato beton

laminato beverin

laminato sherwood ln66

laminato sherwood 70

laminato sherwood 71

laminato sherwood 72

laminato vintage

matrix ciliegio europa

LAMINATI

Laminates / Laminate



matrix wengè 02

matrix bamboo

matrix rovere sbiancato 01

matrix grigio fumo

rovere grigio tranché

rovere miele tranché

abete grigio

abete miele spazzolato

LAMINATI

Laminates / Laminate



bianco spazzolato

grigio carbone spazzolato

GUIDE PER CASSETTI

Drawer guides / Schubkastenführungen



Guida standard
Standard guide / Standardführung



Guida optional
Optional guide / Optional erhältliche Führung

ABBINAMENTI

Coordinates / Zusammenstellungen

| | | | | | | | | | |
|--|---|--|--|---|--|--|--|--|---|
| | <p># MOOD 01</p> <p>01 laminato beverin</p> <p>02 laccato opaco 7044</p> <p>03</p> | <p># MOOD 02</p> <p>01 laccato opaco 9003</p> <p>02 matrix bianco</p> <p>03 rovere grigio tranché</p> | | <p># MOOD 07</p> <p>01 rovere sbiancato</p> <p>02 laccato opaco 9003</p> <p>03</p> | <p># MOOD 08</p> <p>01 laminato vintage</p> <p>02 laccato opaco 3022</p> <p>03 laccato opaco 1013</p> | | <p># MOOD 13</p> <p>01 laccato opaco 7001</p> <p>02 rovere miele tranché</p> <p>03</p> | | <p># MOOD 14</p> <p>01 laccato opaco 5009</p> <p>02 matrix grigio fumo</p> <p>03</p> |
| | <p># MOOD 03</p> <p>03 laccato opaco 9003</p> <p>01 laminato beton</p> <p>02</p> | <p># MOOD 04</p> <p>01 laccato opaco 7045</p> <p>02 abete grigio</p> <p>03</p> | | <p># MOOD 09</p> <p>01 laminato sherwood 71</p> <p>02</p> <p>03 laccato opaco 2001</p> | <p># MOOD 10</p> <p>01 laminato sherwood 72</p> <p>02</p> <p>03 laccato opaco 3013</p> | | <p># MOOD 15</p> <p>01 grigio carbone spazzolato</p> <p>02</p> <p>03 laccato opaco 6034</p> | | <p># MOOD 16</p> <p>01 matrix ciliegio</p> <p>02</p> <p>03 laccato opaco 6033</p> |
| | <p># MOOD 05</p> <p>01 abete miele spazzolato</p> <p>02</p> <p>03</p> | <p># MOOD 06</p> <p>01 matrix bamboo</p> <p>02</p> <p>03 laccato opaco 9003</p> | | <p># MOOD 11</p> <p>01 matrix wengé</p> <p>02</p> <p>03 laccato opaco 4009</p> | <p># MOOD 12</p> <p>01 laminato sherwood 70</p> <p>02</p> <p>03</p> | | <p># MOOD 17</p> <p>01 laminato beton</p> <p>02</p> <p>03 laccato opaco 1023</p> | | <p># MOOD 18</p> <p>01 laccato opaco 6011</p> <p>02 laminato sherwood 72</p> <p>03</p> |

concept e art direction
imago design

fotolito e stampa
grafiche antiga
luglio 2015

VICTORIA è un marchio
©Pozzebon srl

POZZEBON SRL
INDUSTRIA MOBILI PER BAGNO

Via P. Mascagni, 16
31038 Paese - Treviso - Italy

t. 0039 0422 959534
t. 0039 0422 450188
f. 0039 0422 450321

www.pozzebonsrl.it
commercialevictoria@novabagno.it